

Fuse Box:

The fuse box (1) is located under the front seat.

The specified fuses are:

10A, 20A

1. Remove the front seat (page 76).
2. Release the tabs (2), then remove the fuse box cover (3).
3. Pull out the old fuse and install a new fuse.
The spare fuses (4) are located in the fuse box.
4. Install the fuse box cover and install the front seat.

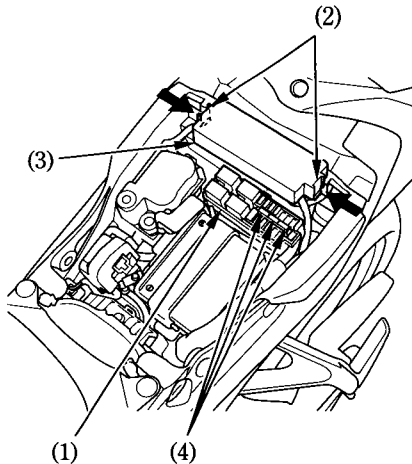

(1) Fuse box
(2) Tabs

(3) Fuse box cover
(4) Spare fuses