

INNER PANEL

The right and left inner panels can be removed in the same manner.

Removal:

1. Remove the middle fairing (page 59).
2. Remove the clips (1).
3. Remove the bolt A (2).
4. Remove the bolt B (3).
5. Remove the inner panel (4) while lifting front of the fuel tank (5).
6. Install the bolts B.

Installation:

- Installation can be done in the reverse order of removal.

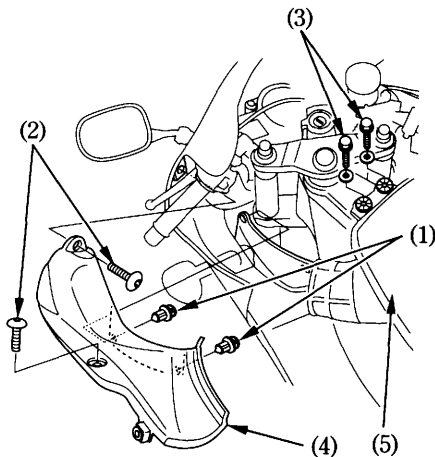

- (1) Clips
(2) Bolt A
(3) Bolt B

- (4) Inner panel
(5) Fuel tank