

TRANSPORTING YOUR FOURTRAX

When you transport your FOURTRAX, we recommend that you carry the vehicle in its normal operating position (on all four wheels) and follow these procedures:

1. Set the parking brake and place the transmission in gear.
2. Turn the fuel cap lever and fuel valve OFF.
3. Secure the vehicle with "tie downs" in the areas shown. Suitable "tie downs" are available from your Honda dealer. Ordinary rope is not recommended because it can stretch under load.

CAUTION:

Using tie downs in any other areas can damage your FOURTRAX.

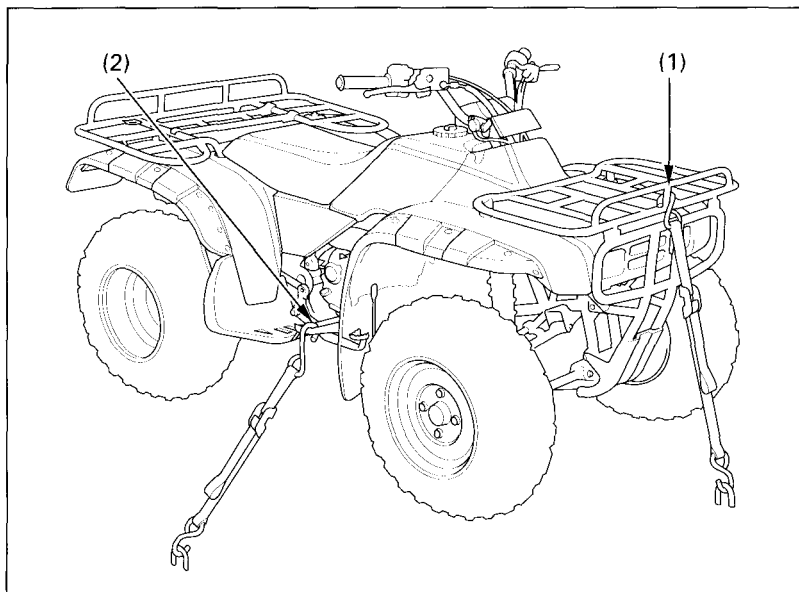

Fig. 4-38 Points to secure FOURTRAX with tie downs

(1) Front cargo rack
(2) Right footpeg