

Carburetor Choke Cable & Knob

Refer to *Safety Precautions* on page 91 .

LEFT HANDLEBAR

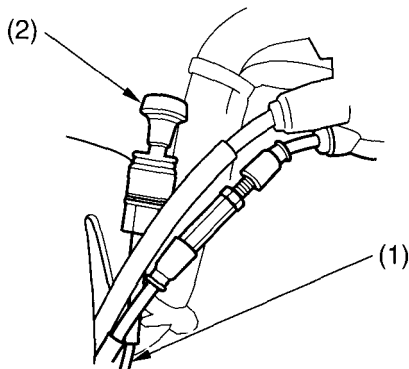

(1) choke cable

(2) choke knob

1. Check the condition of the choke cable (1).
2. Check the operation of the choke knob (2).

If the cable is damaged or kinked, have it replaced by your Honda dealer.