

Fuse box:

The fuse box is located under the seat.

The specified fuses are:

10A , 20A

1. Remove the seat (page 44).
2. Open the fuse box cover (1).
3. Pull out the old fuse and install a new fuse.
The spare fuses (2) are located in the fuse box.
4. Close the fuse box cover and install the seat.

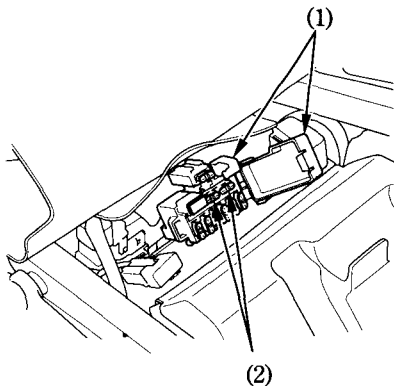

- (1) Fuse box cover
(2) Spare fuses